



- **L**aparoscopy
- **U**rology
- **H**ysteroscopy
- **A**rthroscopy
- **S**inoscopy
- **E. N. T.**

Content

Laparoscopy 1 - 7

Camera, Monitor, Telescope, Trocars Veress Insufflation Cannula, Suction & Irrigation Tube Monopolar Instruments, Fan Retractors, Clip Applicator, Needle Holding Modular Bipolar Coagulation Forceps, Liver Retractor Modular Instrument Handles Rotatable / Detachable, Modular Shaft

Urology 8 - 13

Camera, Monitor, Telescope, Cysto-Ureteroscope Sheaths, Endoscope Bridges Forceps-Flexible, Semi-rigid and Rigid Continuous Flow Resectoscope Sheaths-(ROTATABLE) Working Elements (Titanium) for Resectoscopes, Saline Bipolar Resection Evacuator and Bladder Syringes, Urethrotome, Stone Extractors Slim Nephroscope, Pneumatic Lithotripter, Irrigation System, Lithotripsy Optical forceps, Stone extractors

Hysteroscopy 14 - 18

Camera, Monitor, Telescope, Single Channel Shaped Sheath Operating Continuous Flow Hysteroscopy, Irrigation System, Morcellator Autoclavable Scopes, Uterus Manipulator, Uterus Manipulator - Myoma Drill Ring Applicators

Sinoscopy & E.N.T. 19 - 18

Sinoscope & Accessories, Otoscope & Accessories, Self Retaining Laryngoscope & Accessories Bronchoscope & Accessories, Sigmoidoscope & Accessories

Laparoscopy



Laparoscopy



822A Camera

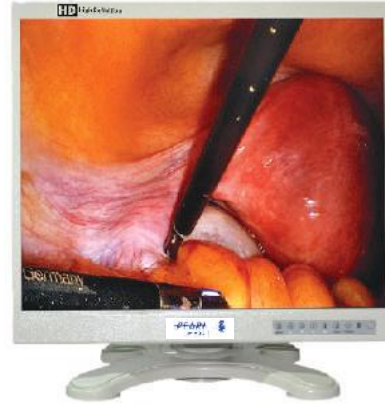

Pearl Monitor 19"



822A Camera New

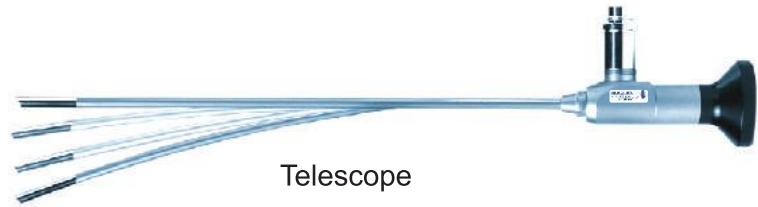

Telescope

Trocars

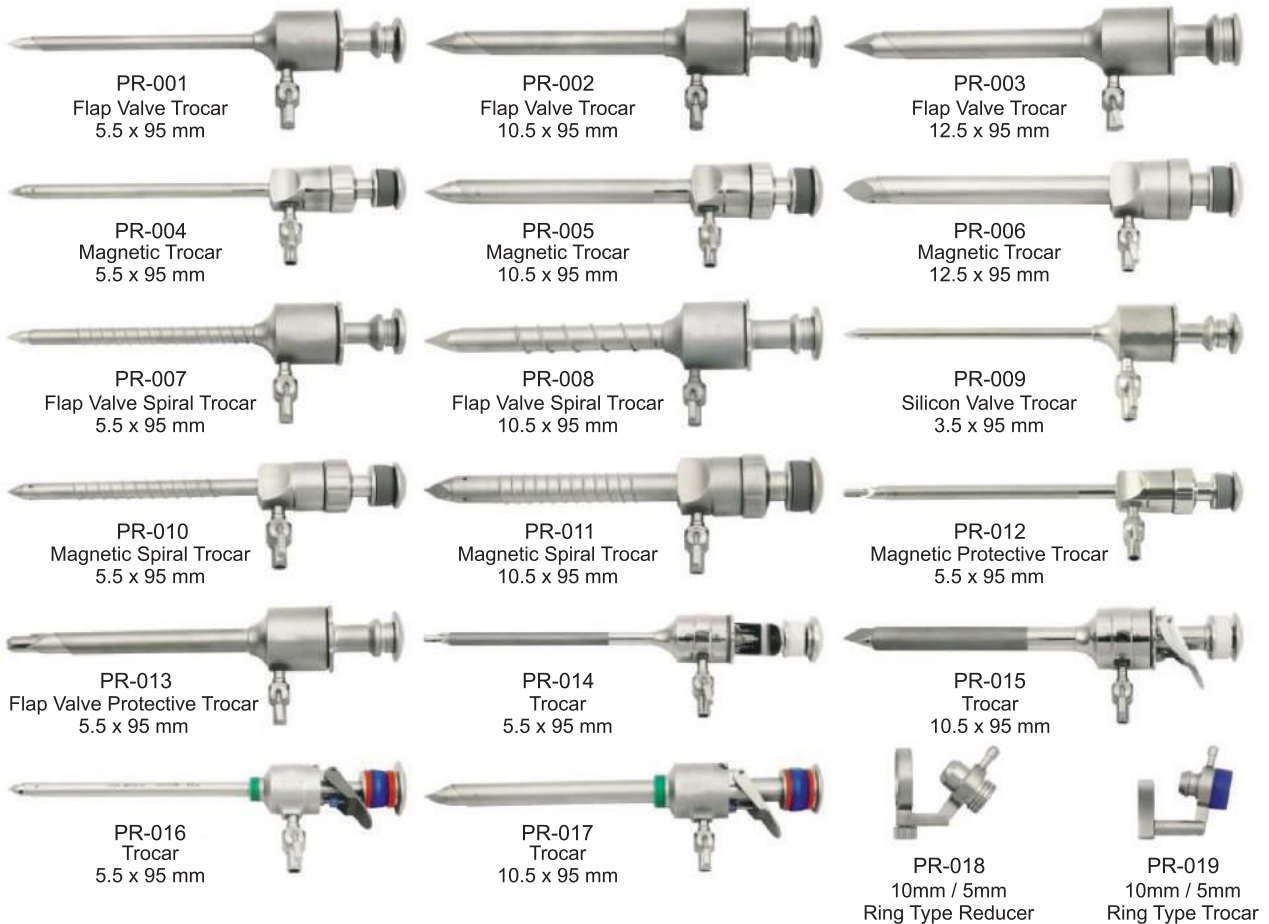

Veress Insufflation Cannula



PR-020



PR-021

Suction & Irrigation Tube

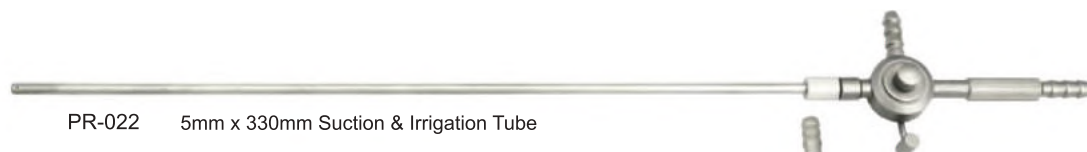

PR-022 5mm x 330mm Suction & Irrigation Tube

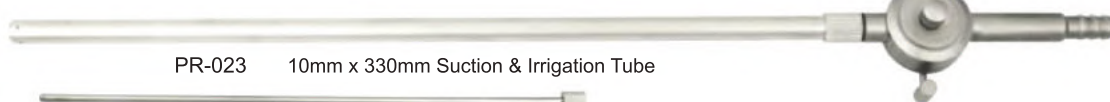

PR-023 10mm x 330mm Suction & Irrigation Tube



PR-024 A Adaptable Suction-Irrigation Tubes

3 mm	330 mm
5 mm	330 mm
10 mm	330 mm



PR-024

Pistol Handle with maintenance-free 2-way valve

Monopolar Instruments

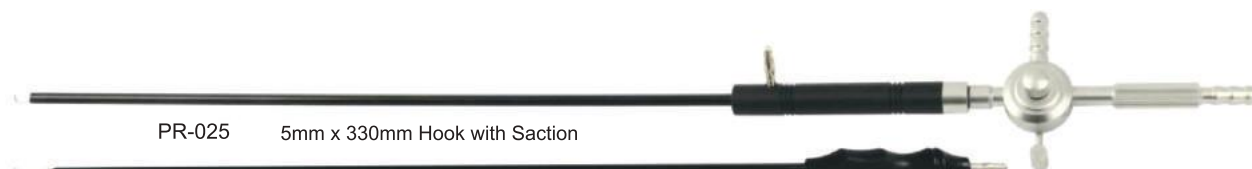

PR-025 5mm x 330mm Hook with Suction



PR-026 5mm x 330mm Hook-Electrode



PR-027
Ballpoint Electrode



PR-028
Needle-Electrode



PR-029
Ceramic Hook-Electrode



PR-030
Scalpel-Electrode



PR-031
Spatula-Electrode

Fan Retractor

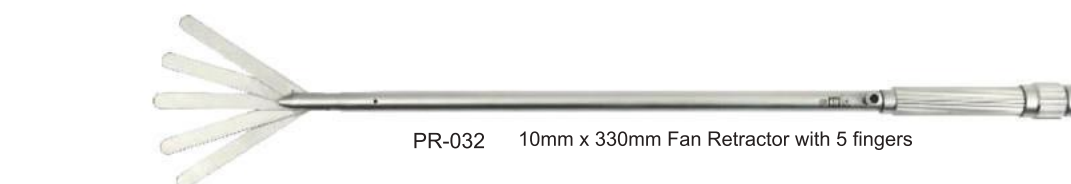

PR-032 10mm x 330mm Fan Retractor with 5 fingers



PR-033 10mm x 400mm Articulating Fan Retractor with 5 fingers



PR-034 5mm x 330mm Fan Retractor with 5 fingers



PR-035 Fan Retractor with 3 fingers

Clip Applicator

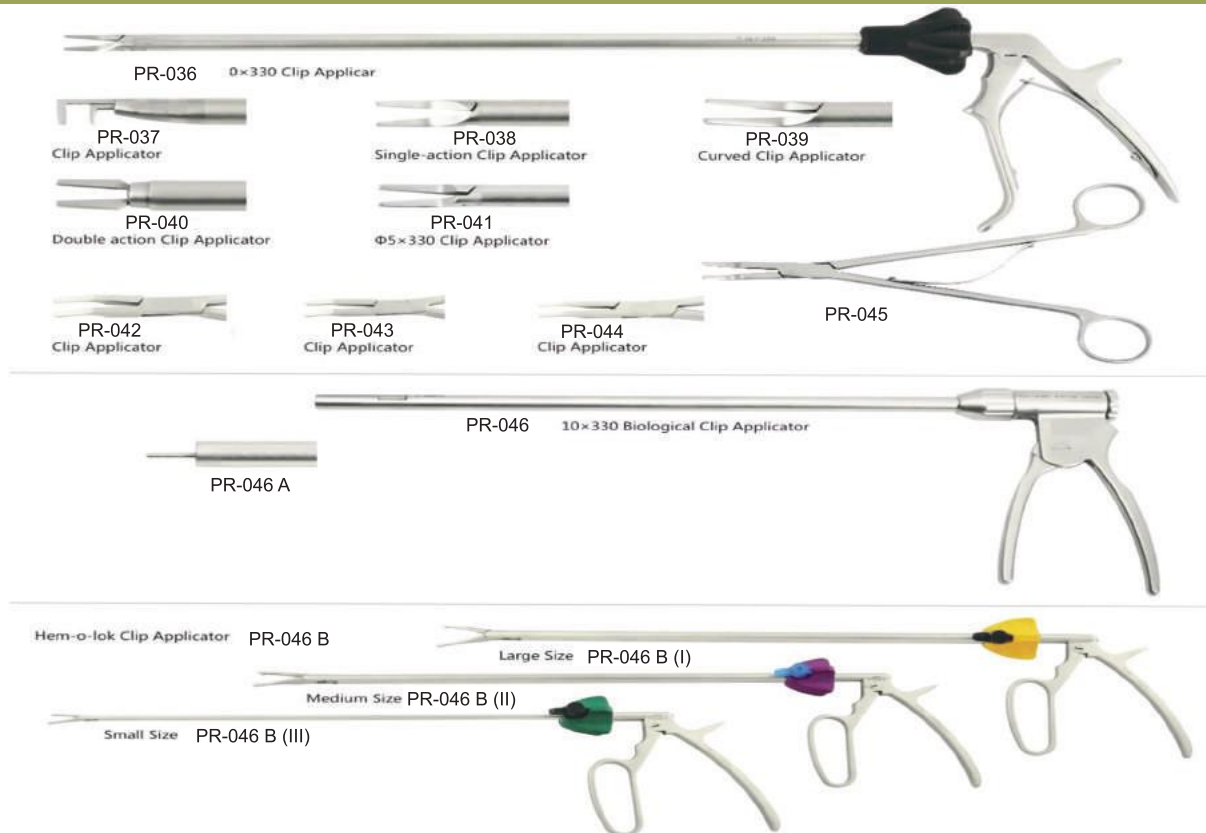

Other Instruments

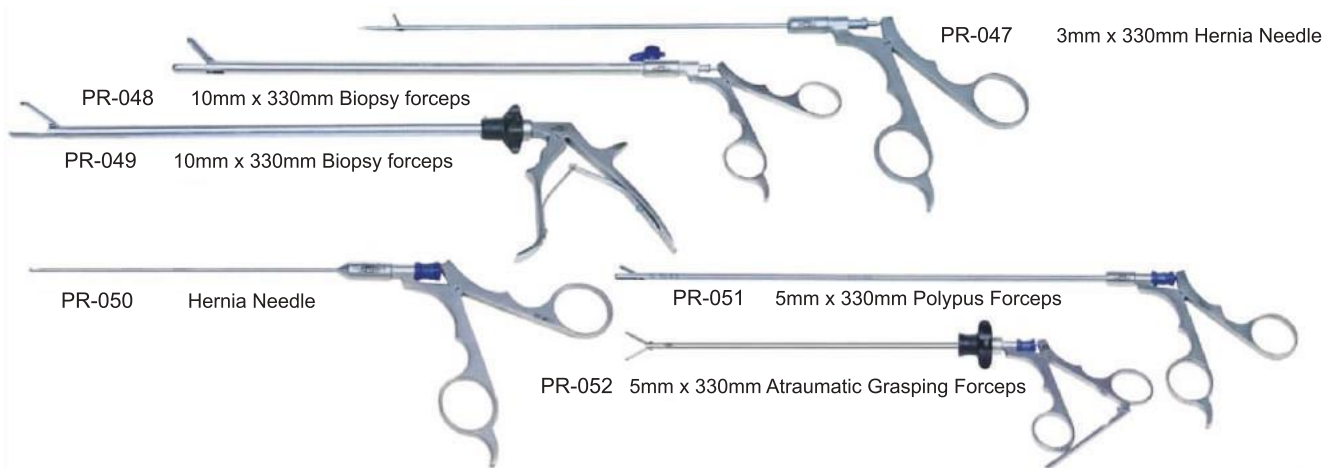

Needle Holding

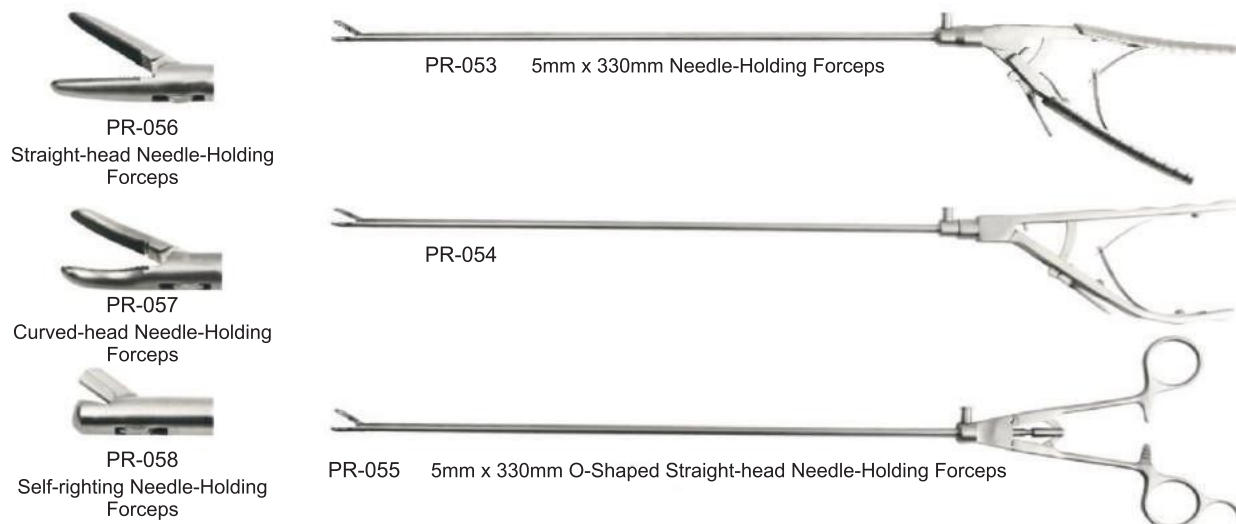

Modular Bipolar Coagulation Forceps

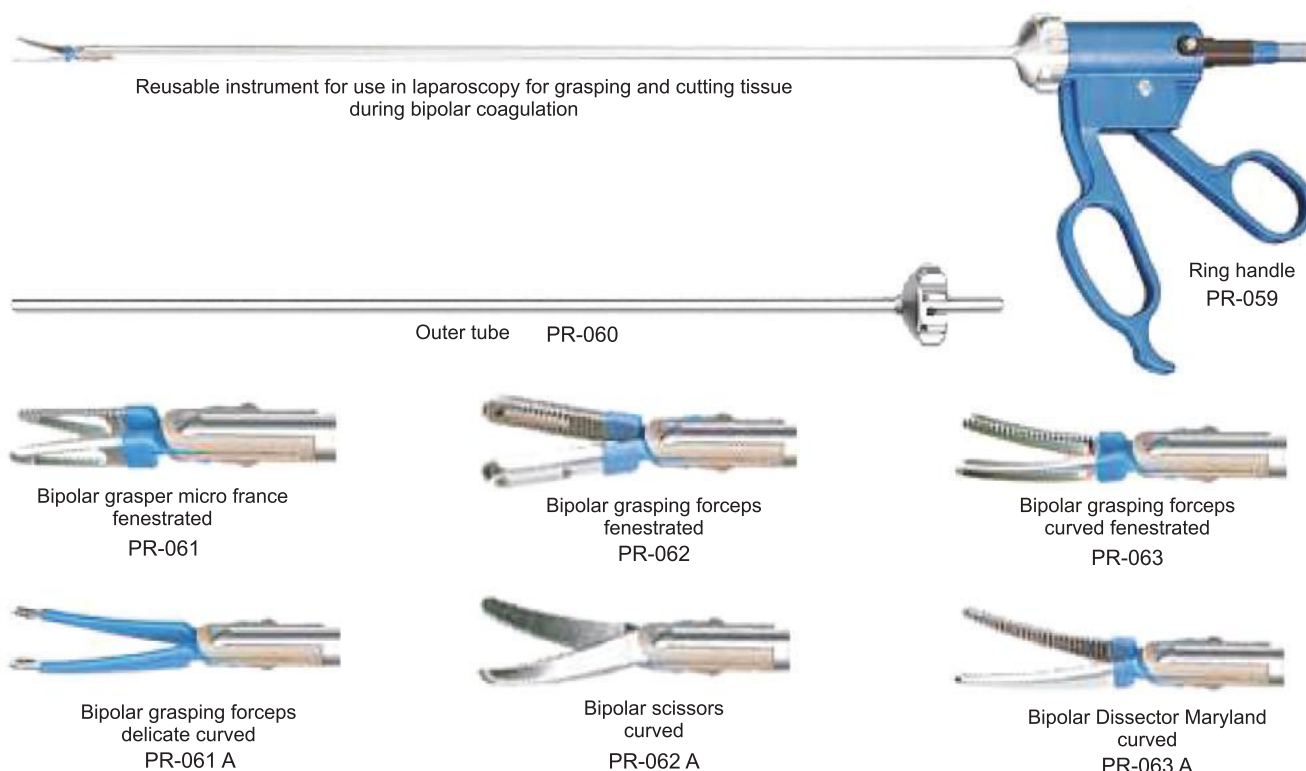

2 Banana Plugs
PR-064



Valleylab
PR-065



Wolf / Martin /
Berchtold / Aesculap
PR-066



Erbe / Select / Storz
PR-067

Liver Retractor

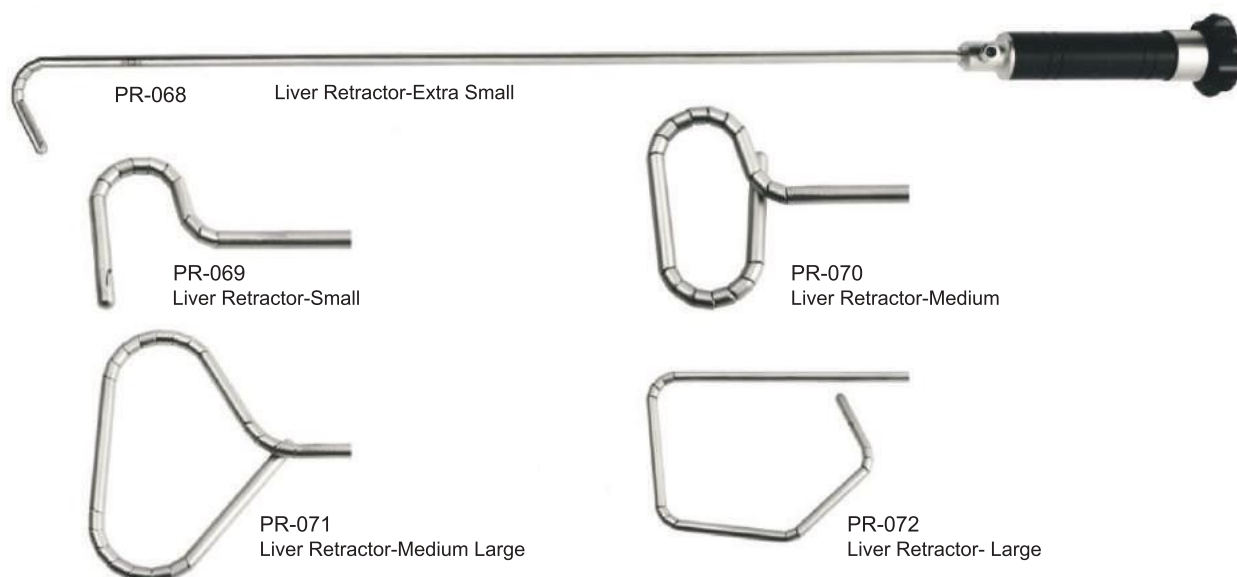

Modular Instrument Handles Rotatable / Detachable



PR-073



PR-074



PR-075



PR-076
5mm x 330mm Dissecting
Forceps, Straight



PR-079
5mm x 330mm Grasping
Forceps with Teeth



PR-082
5mm x 330mm Intestine
Forceps



PR-077
5mm x 330mm Dissecting
Forceps, Curved



PR-080
5mm x 330mm Punch
Grasping Forceps



PR-083
5mm x 330mm Claw
Grasper



PR-078
5mm x 330mm Scissors
Curved



PR-081
5mm x 330mm U-Shaped
Handle Grasping Forceps



PR-084
5mm x 330mm Grasping
Forceps with Teeth



PR-085



PR-086



PR-087



PR-088
5mm x 330mm Cholecyst
Forceps with Teeth



PR-091
5mm x 330mm Lung
Lobe Forceps



PR-094
5mm x 330mm Dissector



PR-089
5mm x 330mm Cholecyst
Forceps with Teeth



PR-092
5mm x 330mm Hernia
Forceps



PR-095
5mm x 330mm Grasper



PR-090
5mm x 330mm Grasping
Forceps with Teeth



PR-093
5mm x 330mm Cobra
Grasper



PR-096
5mm x 330mm Grasper

Modular Shafts

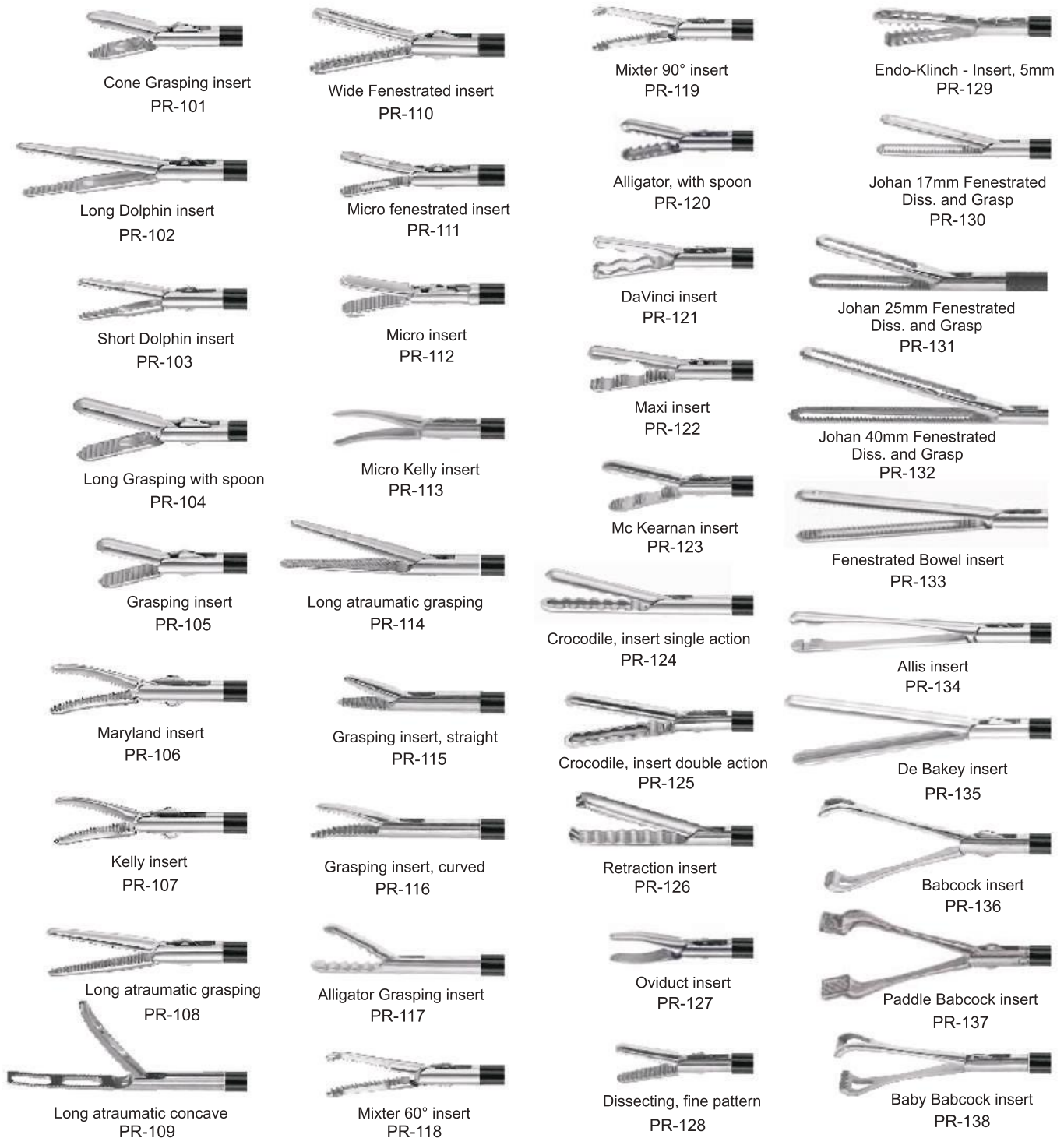
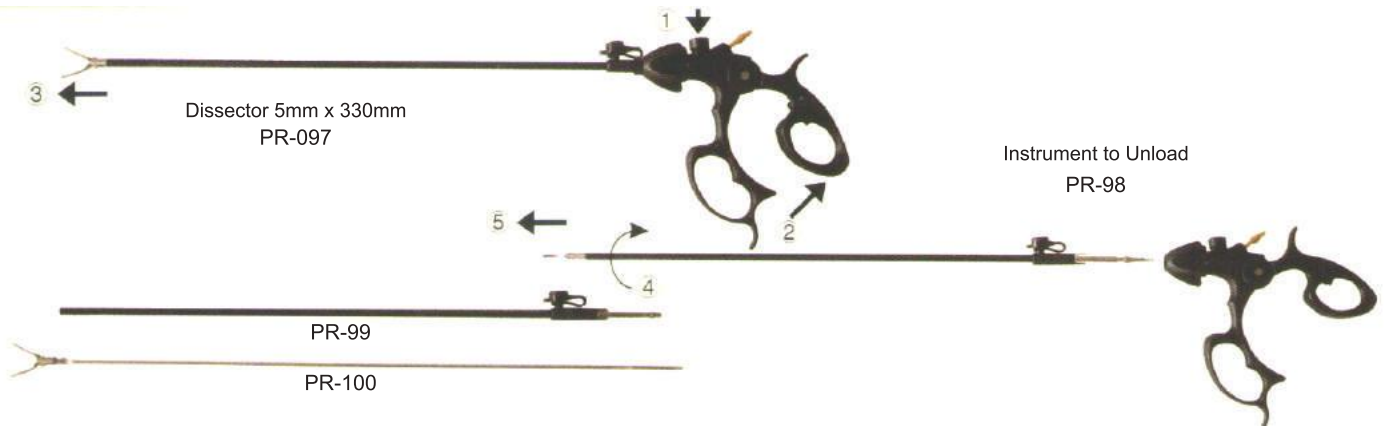

Urology



Urology



822C Camera

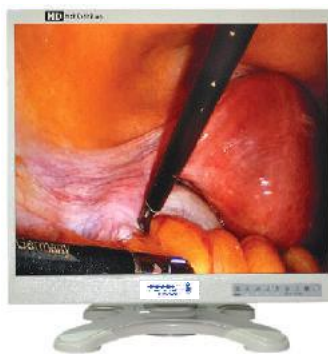

Pearl Monitor 24"

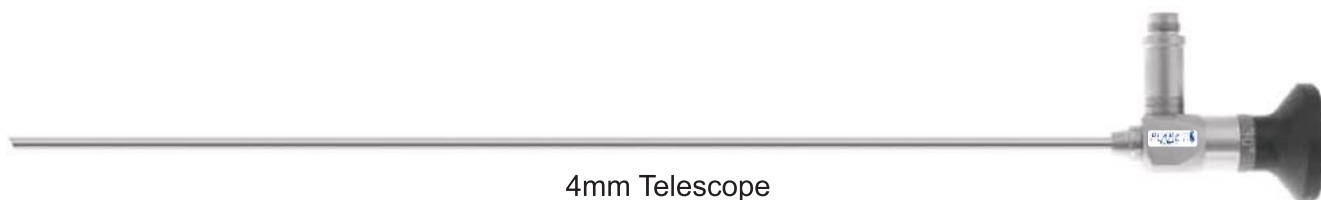

4mm Telescope

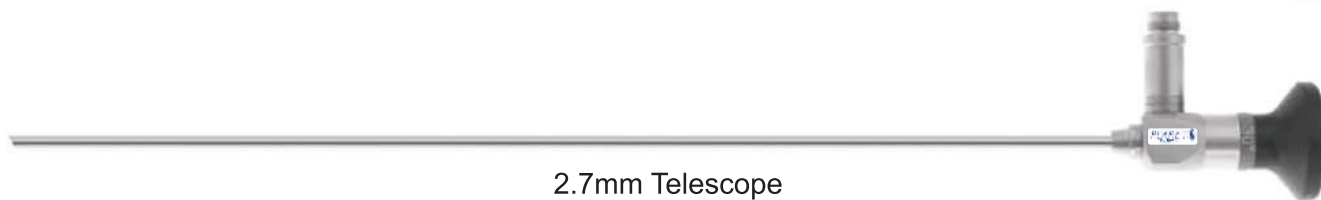

2.7mm Telescope

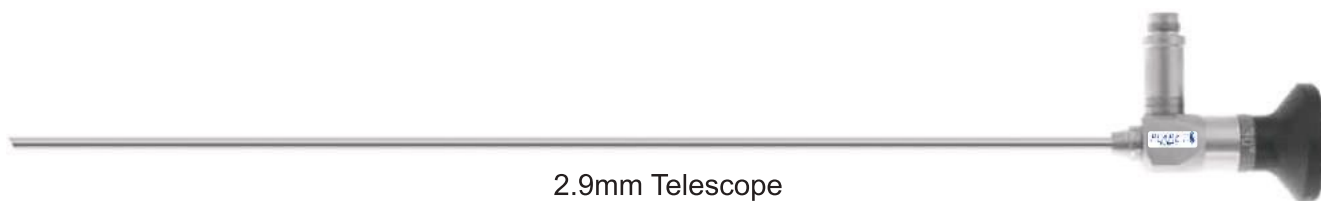

2.9mm Telescope

Cysto-Ureteroscope Sheaths

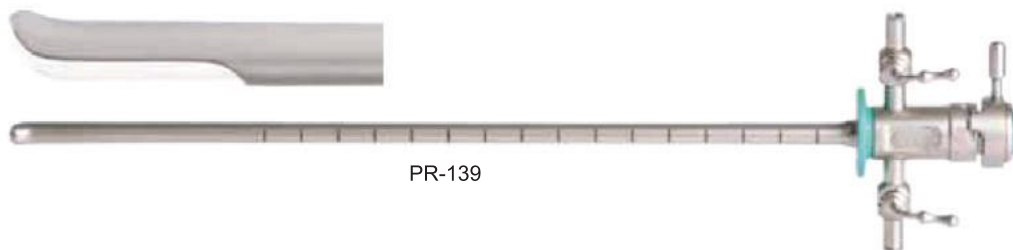

PR-139

Endoscope Bridges



PR-140



PR-141



PR-142



PR-143

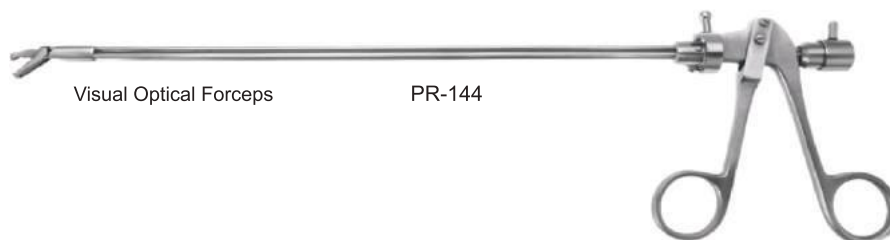

Visual Optical Forceps

PR-144

Forceps-Flexible, Semi-rigid and Rigid

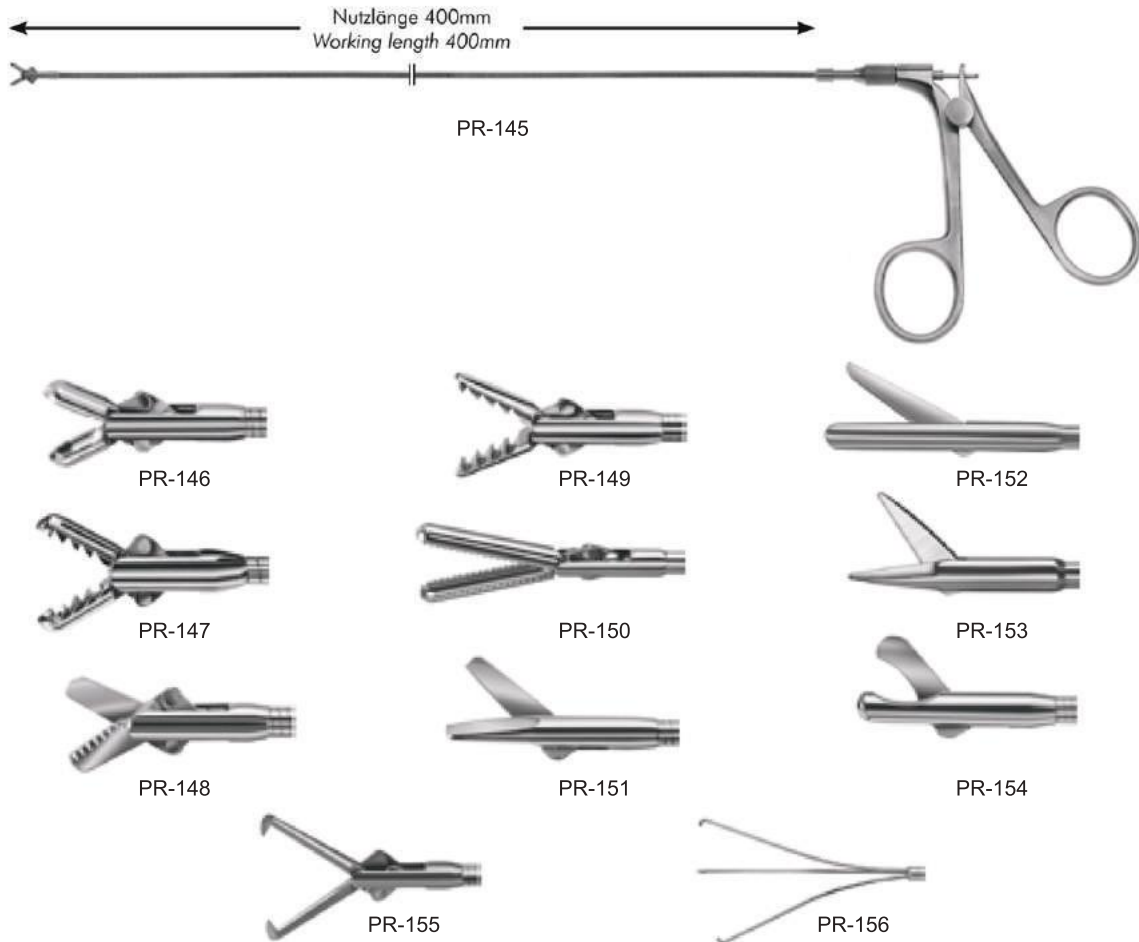

Continuous Flow Resectoscope Sheaths-ROTATABLE

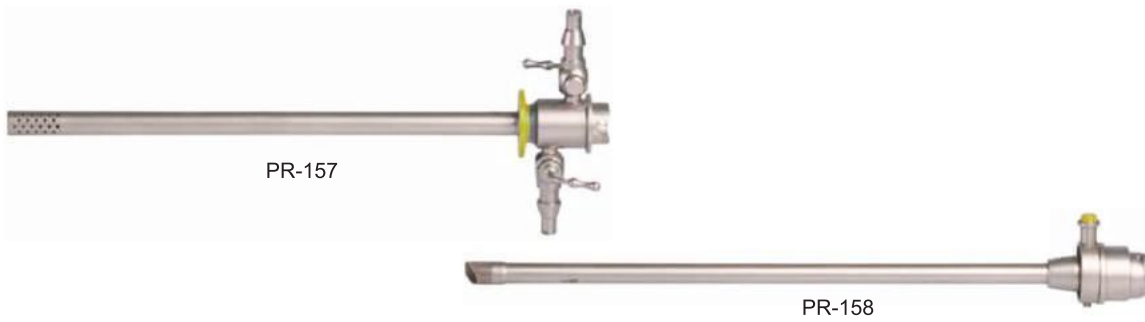

Working Elements (Titanium) for Resectoscopes

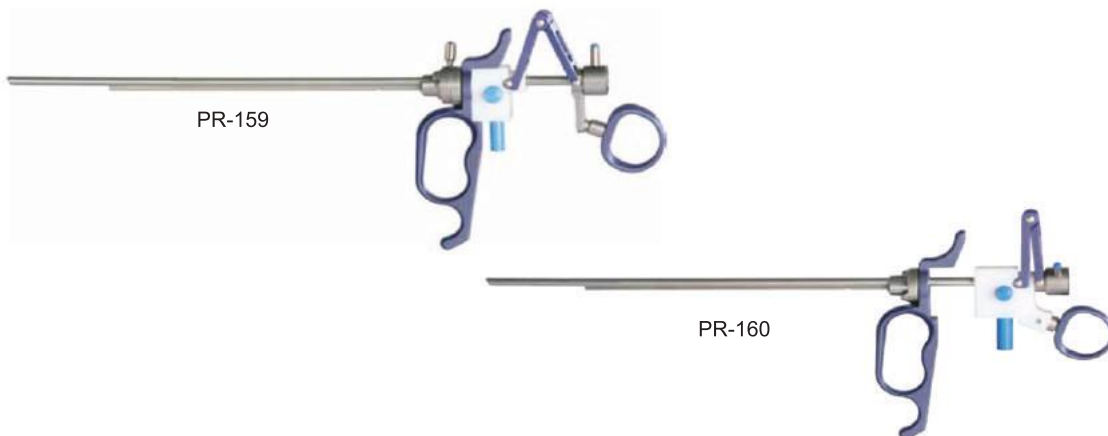

Saline Bipolar Resection

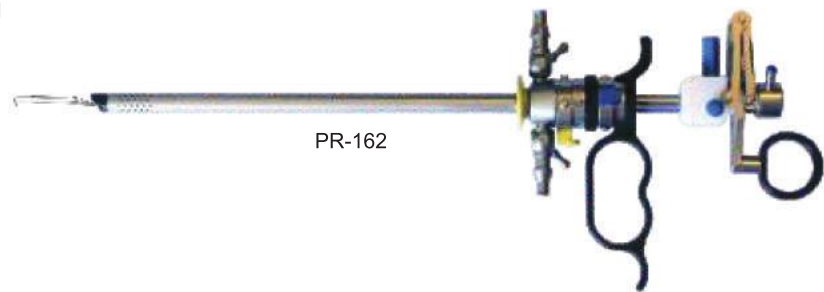
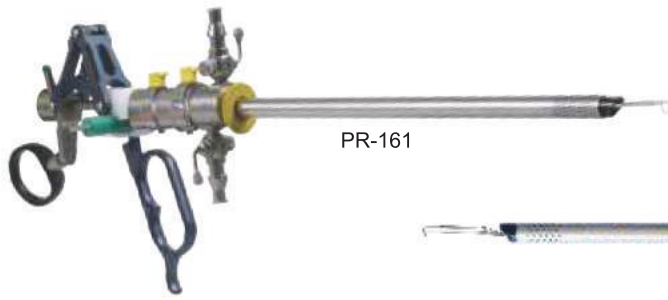

Evacuator and Bladder Syringes



Urethrotome



Stone Extractors



Slim Nephroscope



Pneumatic Lithotripter

Technical Specification :-

Display	7 Segment Digital Display
Supply Voltage	230VAC @ 50Hz / ± 10% 110VAC @ 60Hz / ± 10% (On Request)
Power Consumption	25 - 30 W
Input Gas	Oxygen / Compressed Dry Air
Inter Pressure Range	4 - 6 Kg / Cm ²
Outlet Pressure Indication	0 - 5 Kg / Cm ² via pressure guage
Frequency	0 cycles per second - 12 cycles per second 14 cycles per second at Power PULSE



PR-171 A



PR-171 B

Salient features of the hand piece

- Sleek and Light Weight
- Compact Dimensions
- Sterilization : Formalin Chamber
- Easy Maintenance
- Long Life time

Irrigation System



PR-171 C

Lithotripsy



PR-171 E



PR-171 D

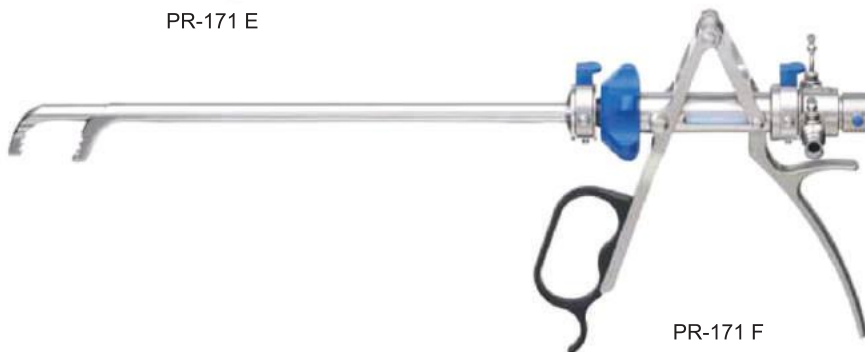

PR-171 F

Optical forceps

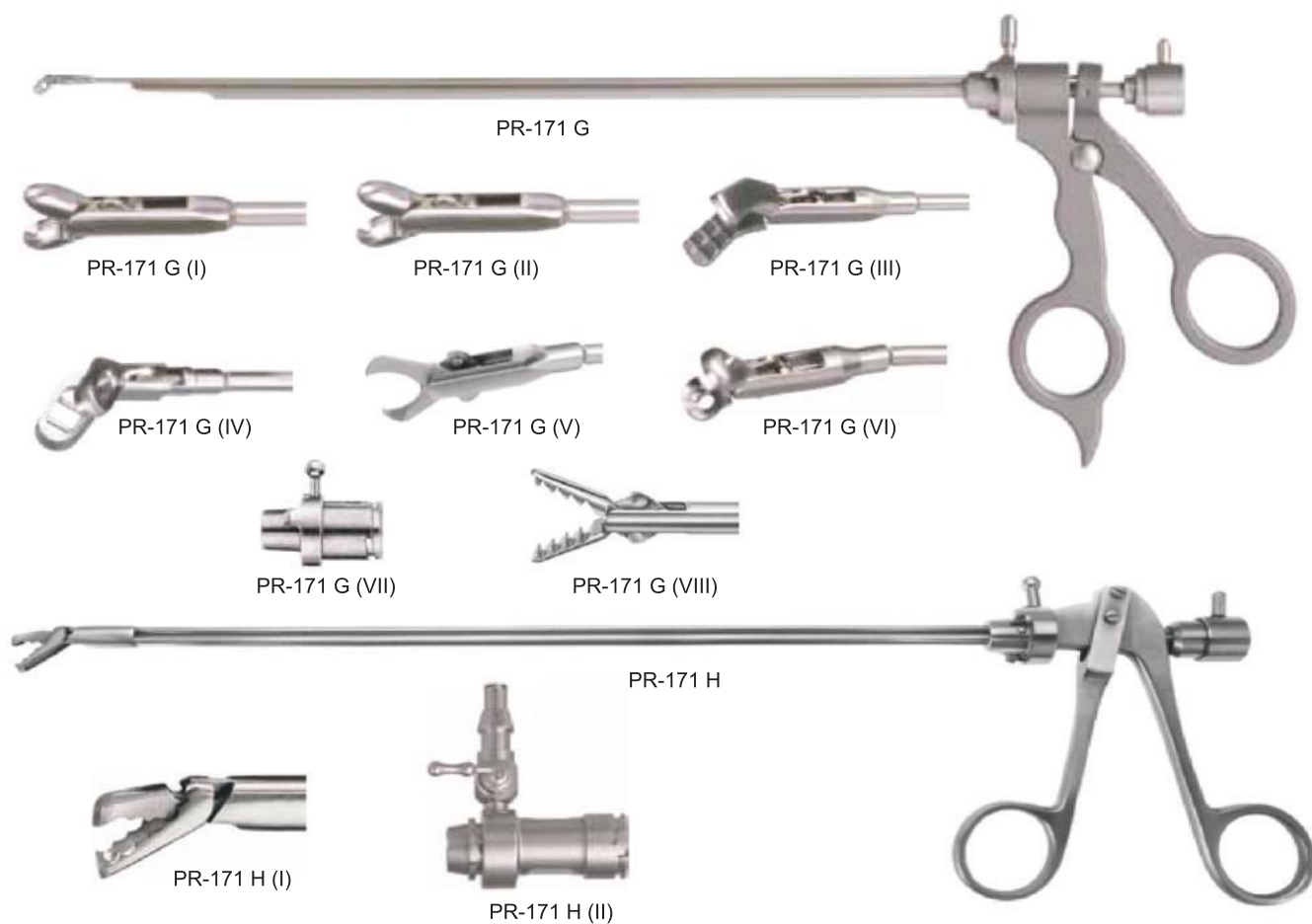

Stone extractors



Stone extractors

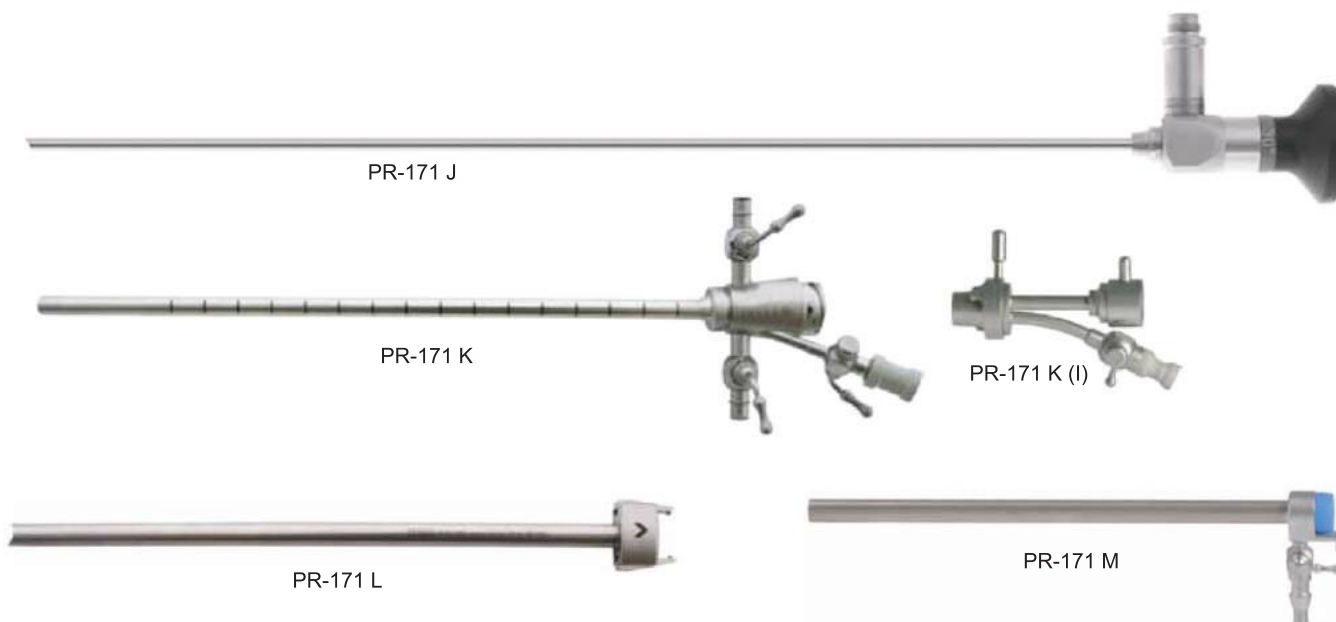

Hysteroscopy



Hysteroscopy



910 HD Camera

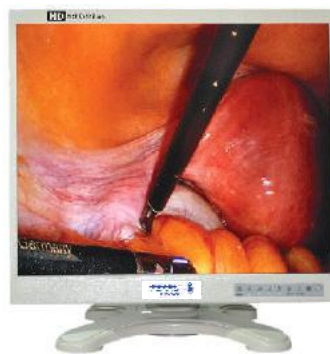

Pearl Monitor 26"

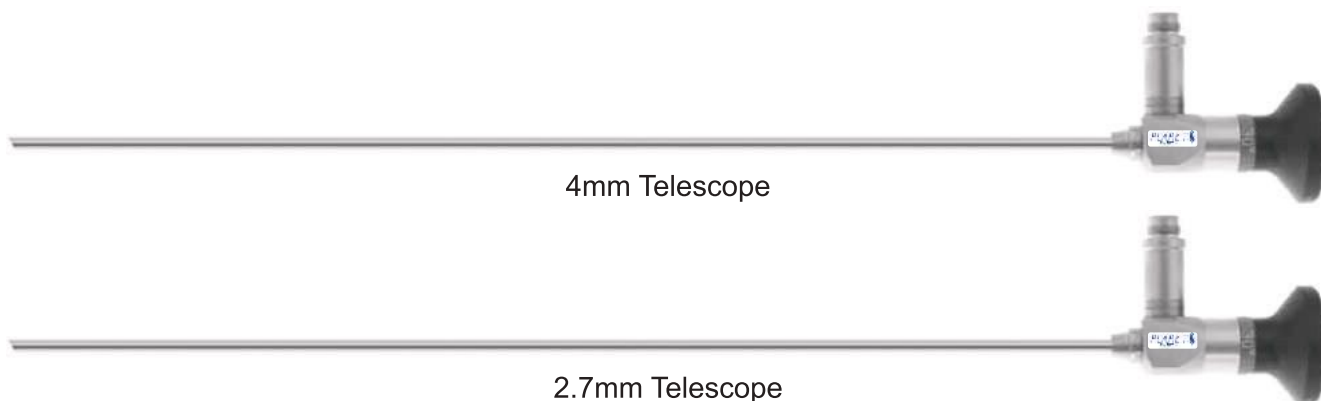

4mm Telescope

2.7mm Telescope

Single Channel Shaped Sheath



PR-172

Operating Continuous Flow Hysteroscopy



Cohen Intra Uterine Probe

PR-173

Flexible Electrodes-Monopolar Connecting Cables PR-174



PR-175

PR-176

PR-177



Diathermy Loops

PR-178

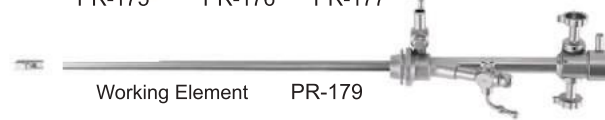

Working Element

PR-179

Nutzlänge 400mm
Working length 400mm

PR-180



PR-181



PR-184



PR-187



PR-182



PR-185



PR-188



PR-183



PR-186



PR-189



PR-190



PR-191

Irrigation System



PR-193



PR-192



PR-194

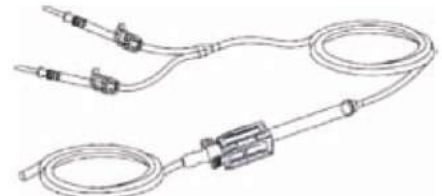

PR-195



PR-196



PR-197



PR-198

Morcellator



PR-199



PR-200



PR-201

Autoclavable Scopes

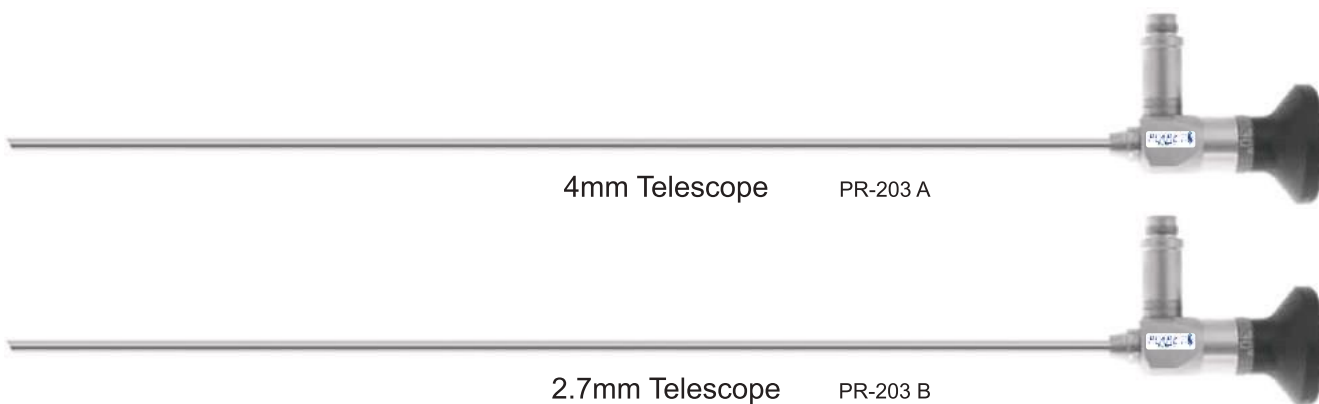

Uterus Manipulator

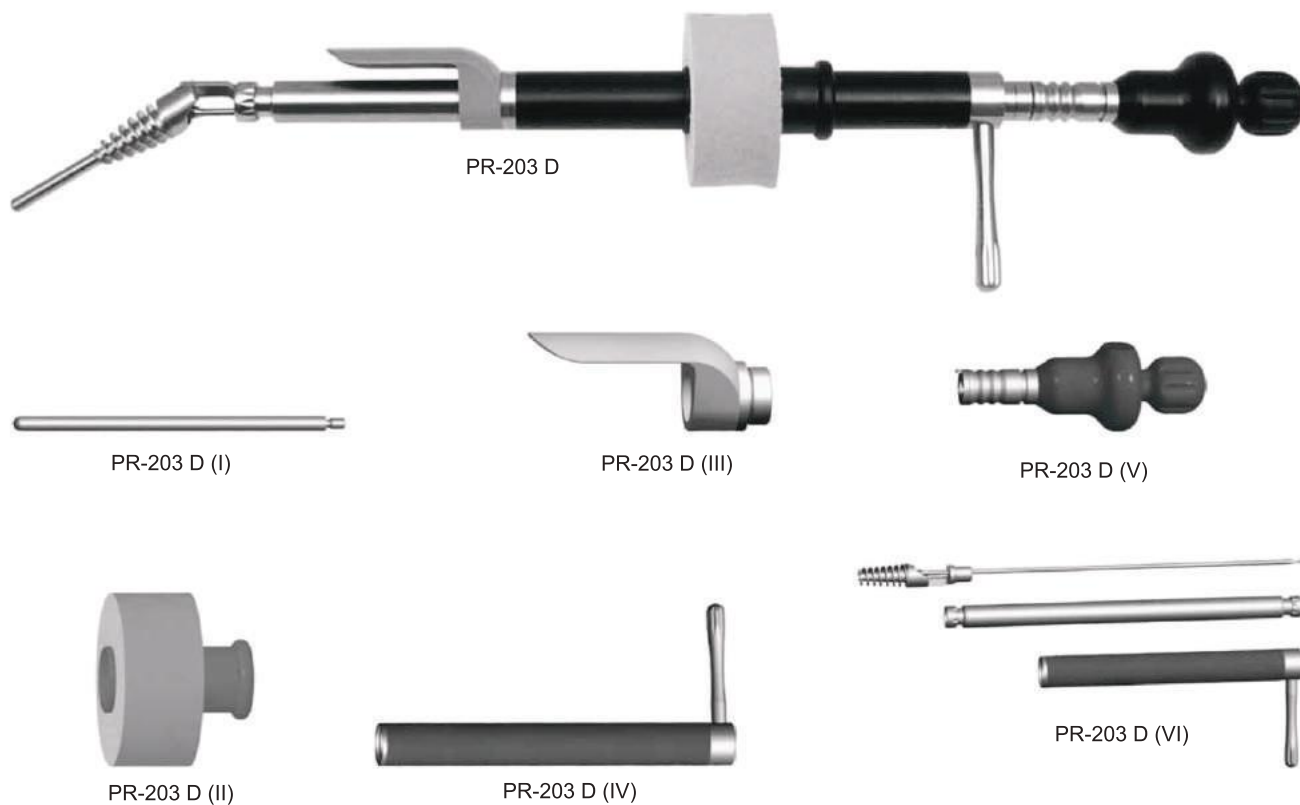
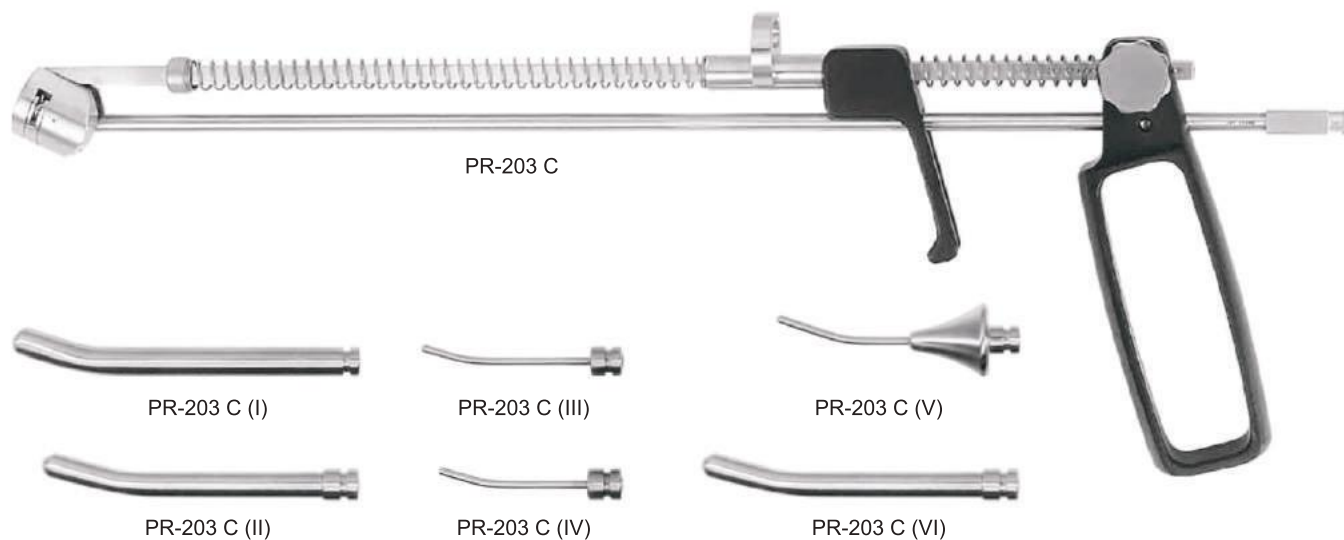

Uterus Manipulator - Myoma Drill



Ring Applicators

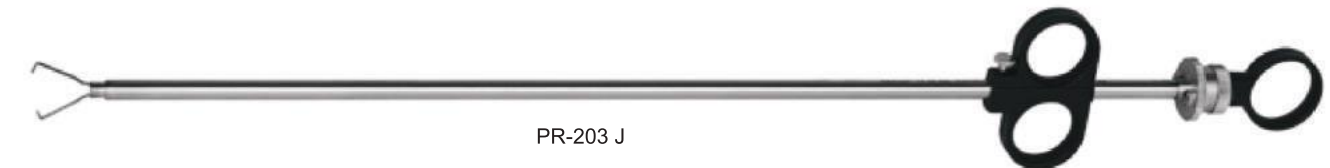
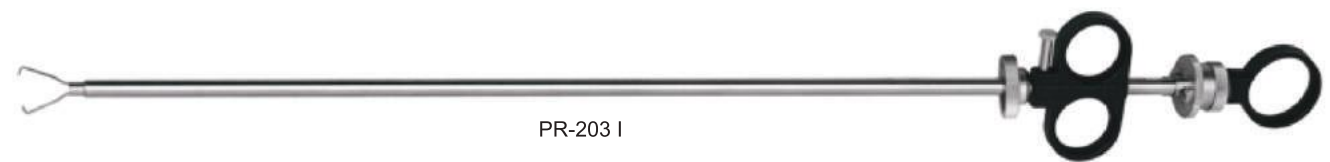
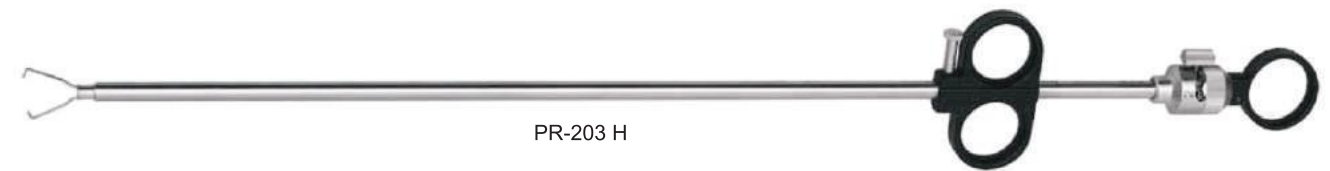

Sinoscopy & E.N.T.



Sinoscope & Accessories

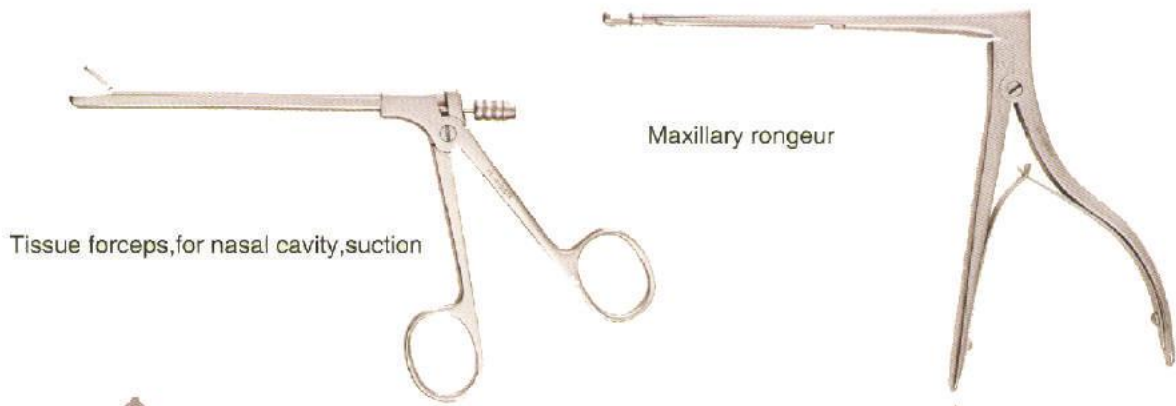

Rongeur, forward



Tissue forceps, for nasal cavity



Tissue forceps, for nasal cavity



Rongeur, backward



Tissue forceps, for nasal cavity, bowl-shaped



Maxillary rongeur



Nasal tissue scissors, straight



Tissue forceps, for nasal cavity, right curved



Tissue forceps, for nasal cavity, spoon-shaped



Nasal tissue scissors, right curved



Tissue forceps, for nasal cavity, suction



Tissue forceps, for nasal cavity



Nasal tissue scissors, left curved



Tissue forceps, for nasal cavity, suction



Optical forceps

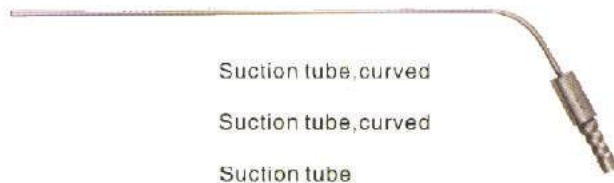
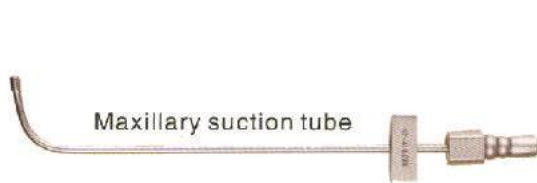

Recommended



- ① Nasal bone restorer
- ② Adenoid box dissecting knife
- ③ Maxillary trocar
- ④ Olive-shaped head (large/middle/small)

Sinoscope & Accessories

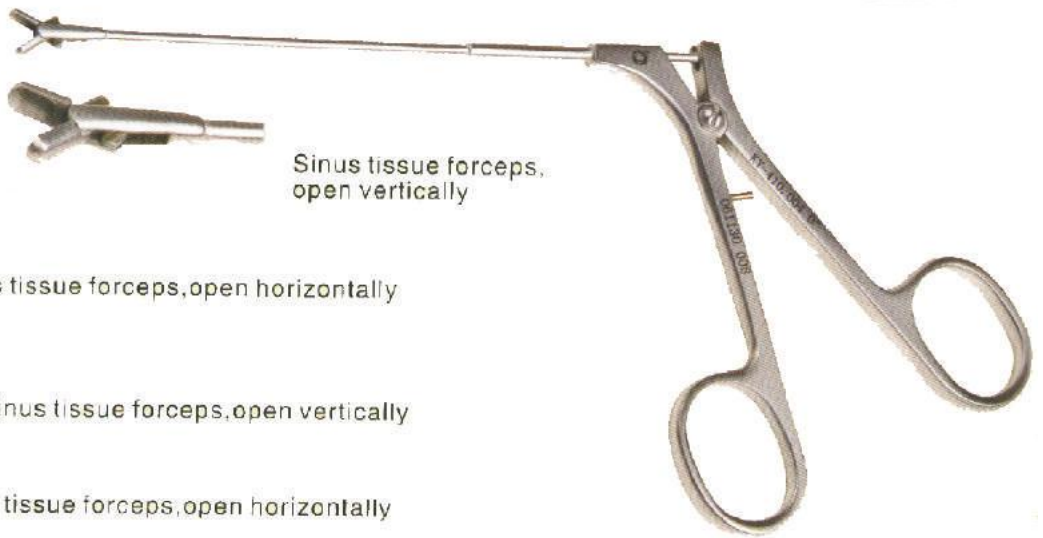
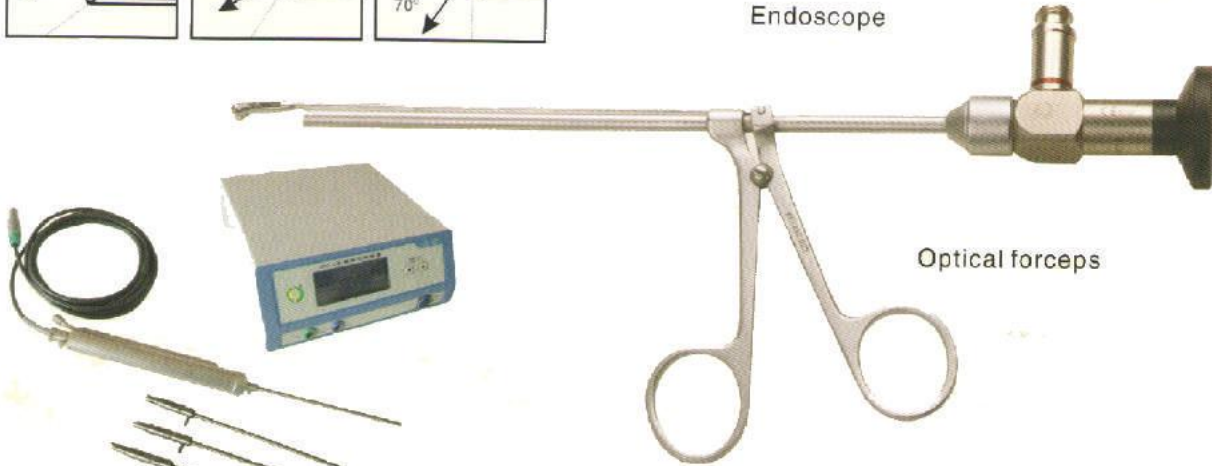
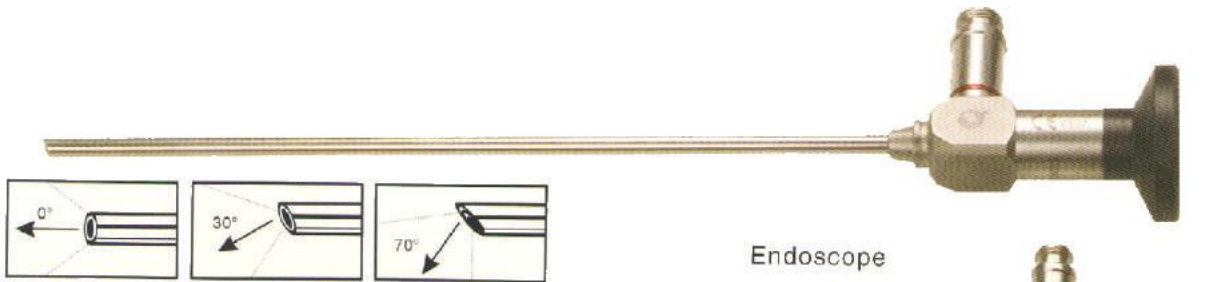

Sinus tissue forceps, open horizontally



Sickle-shaped knife, sharp



Sinus curette, no hole



Elevator, single head



Sickle-shaped knife, blunt



Sinus curette, with hole



Otoscope & Accessories

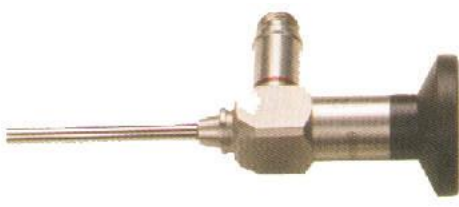

Otoscope



Otoscope



Forceps, upward-curved



Scissors, for middle ear



Malleus Forceps



Forceps, straight



Forceps, short wheat-shaped



Forceps, for stirrup bone



Forceps, upward-curved



suction tube, Straight
suction tube, Curved
suction tube, Straight
suction tube, Curved



Needle, for stirrup bone, straight



Elevator



Knife, for stirrup bone/sinew



Curette, right curved



Needle, for stirrup bone



Curette



Cutting knife, straight



Round chisel, straight



Hook, blunt



Curette



Elevator, straight



Round chisel, curved



Hook, blunt



Cutting knife, sharp



Curette, left curved



Flat chisel



Hook, sharp



Cutting knife, blunt



Stirrup bone drill



Hook

Self Retaining Laryngoscope & Accessories



Micro-larynx scissors, straight



Micro-larynx scissors, upward 45°



Micro-larynx larynx forceps, bowl-shaped, straight



Micro-larynx scissors, left curved



Micro-larynx forceps, straight



Micro-larynx forceps, bowl-shaped, left curved



Micro-larynx scissors, right curved



Micro-larynx forceps, bowl-shaped, upward



Micro-larynx forceps, bowl-shaped, right curved



micro-larynx forceps



micro-larynx forceps, alligator

- ① larynx hook
- ② larynx needle
- ③ laryngotome
- ④ laryngotome
- ⑤ larynx hook

- 1 larynx hook
- 2 larynx needle
- 3 laryngotome
- 4 laryngotome
- 5 larynx hook

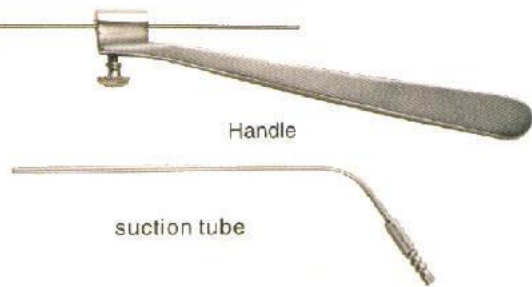

Recommended



Mouth gag with fiber



Anesthetic syringe

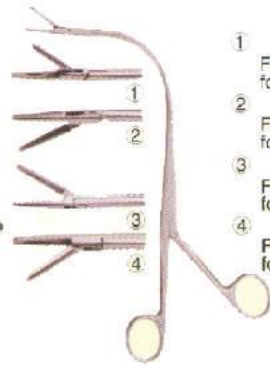

- ① Fish bone taking laryngeal forceps(front open)
- ② Fish bone taking laryngeal forceps(back open)
- ③ Fish bone taking laryngeal forceps(left open)
- ④ Fish bone taking laryngeal forceps(right open)

Bronchoscope & Accessories

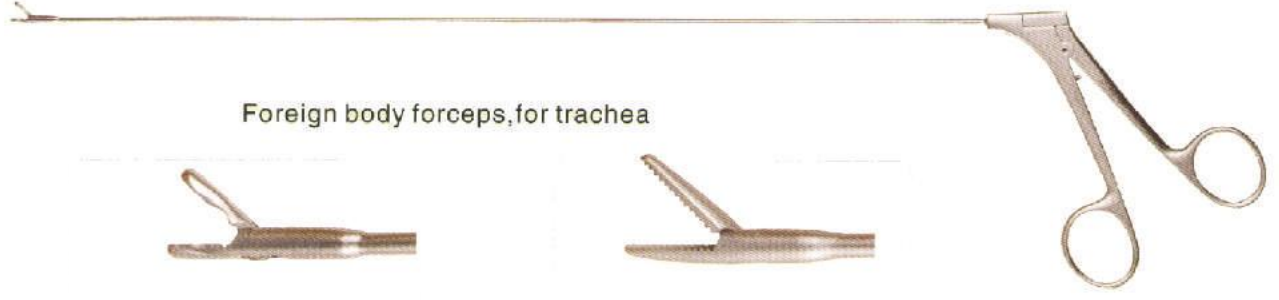
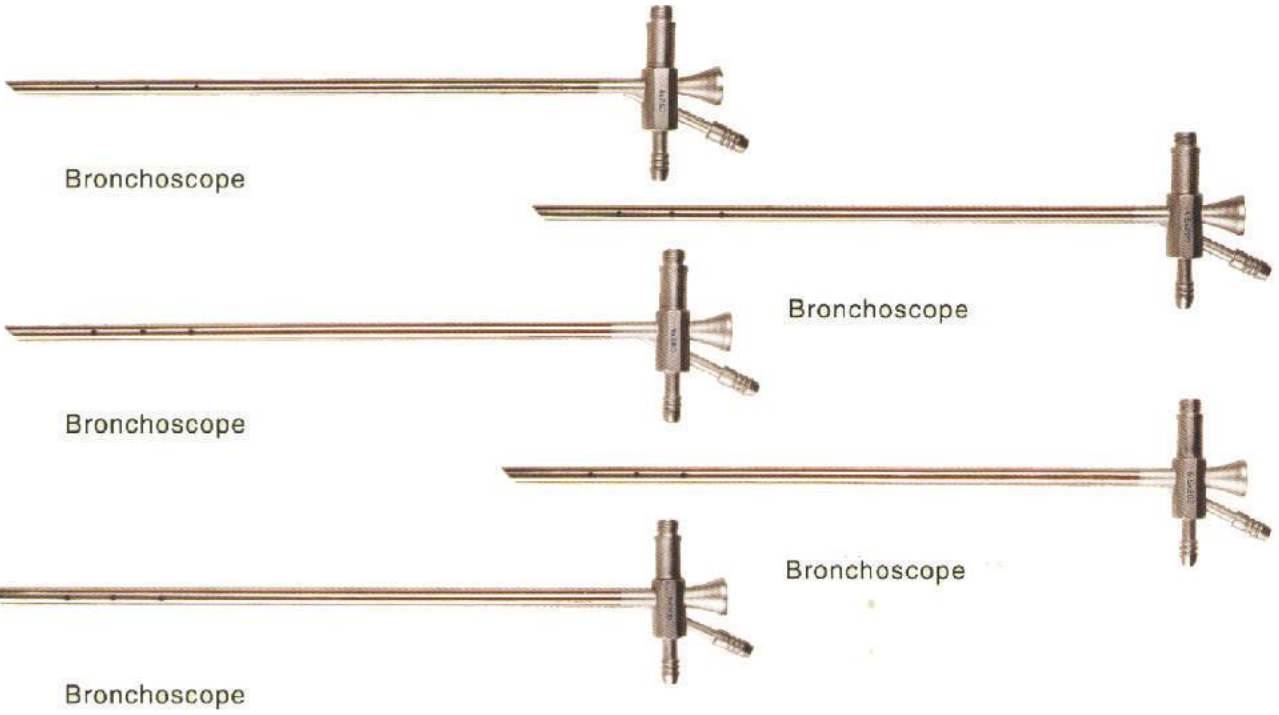

Foreign body forceps, for trachea, peanut-shaped



Foreign body forceps, for trachea, alligator



Foreign body forceps, for trachea, wheat-shaped



Foreign body forceps, forceps, for trachea, three-prong

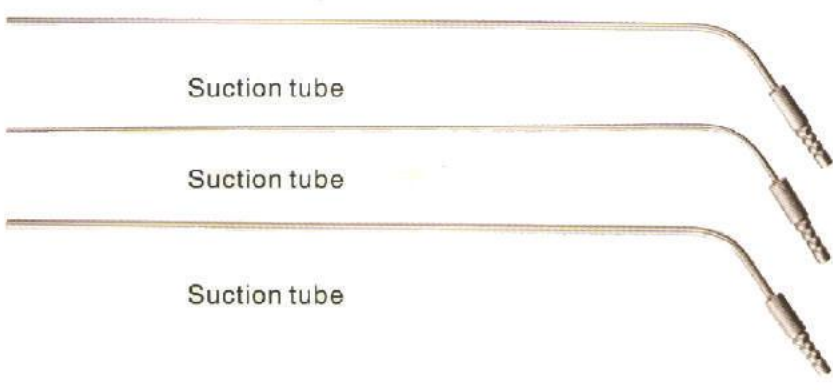

Fiber Optic cable

Sigmoidoscope & Accessories



Observing endoscope

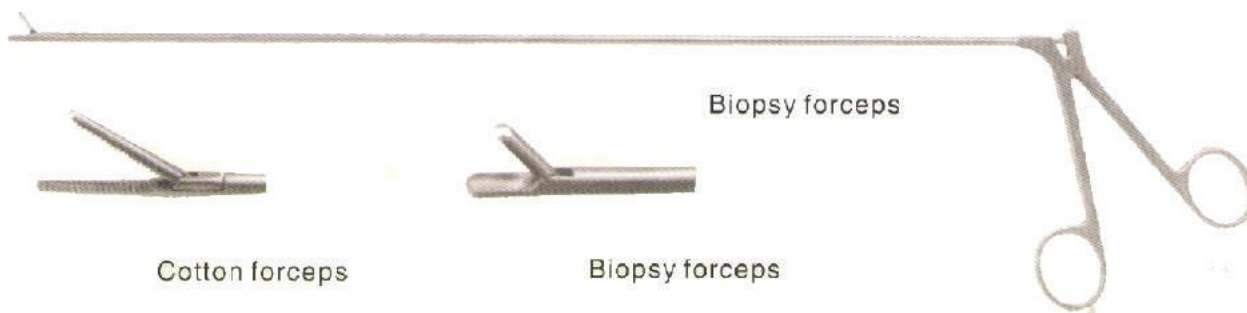

Biopsy forceps

Cotton forceps

Biopsy forceps



suction tube, large
suction tube, small



Fiber-esophagoscope



Foreign body forceps, for
esophagus, backward toothed



Foreign body forceps,
for esophagus, brace-shaped



Foreign body forceps, for
esophagus, duck-mouth



Foreign body forceps, for
esophagus, bowl-shaped, straight



Esophagoscope handle



Suction tube

Services and Marketed in india :

S.I. SURGICAL CORPORATION

Regd. Off : DU Market, First Floor, Bankra Main Road
Howrah-711 403, W.B., India

Corp Off : 265 Roy Bahadur Road
Kolkata - 700 053

Phone : +91 33-26530085 (4 lines)

Mobile : +91 98362 96422

Website : www.sisurgical.co.in

E-mail : info@sisurgical.co.in
sisurgicalcorp@gmail.com



www.pearlendoskope.org